

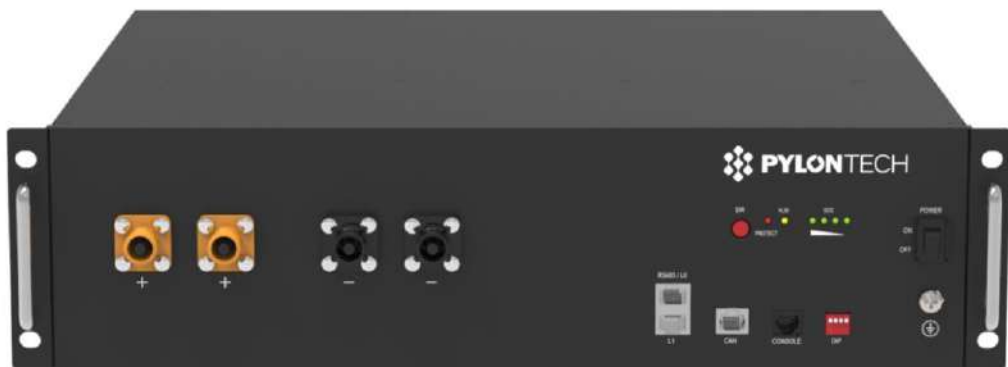

PYLONTECH



Rechargeable Lithium-Ion Battery

UP2500 Product Manual



Pylon Technologies Co., Ltd.

No. 73, Lane 887, Zu Chongzhi Road, Zhangjiang Hi-Tech Park Pudong,
Shanghai 201203, China



This manual introduces UP2500 from Pylontech. Please read this manual before you to install the battery and follow the instruction carefully during the installation process. Any confusion, please contact Pylontech immediately for advice and clarification.

Content

1. SAFETY PRECAUTIONS	4
1.1 Before Connecting.....	4
1.2 In Using.....	5
2. INTRODUCTION	6
2.1 features:.....	6
2.2 Specifications.....	7
2.3 Equipment Interface Instruction	8
UP2500 Product Front Interface.....	8
LED Indicators Instructions.....	8
Definition of RJ45 Port Pin.....	10
Definition of RJ11 Port Pin.....	10
3. SAFE HANDLING OF LITHIUM BATTERIES GUIDE	11
3.1 Schematic Diagram of Solution.....	11
3.2 Explanation of Symbol.....	11
3.3 Tools	12
3.4 Safety Gear	12
4. INSTALLATION	13
4.1 Package Items.....	13
Unpacking and check the Packing List	13
4.2 Installation Location.....	14
Installation.....	15
A. Put battery modules into cabinet and connect the cables:.....	15
B. Power On.....	18
5. TROUBLE SHOOTING STEPS	20
5.1 Problem determination based on:	20
5.2 Preliminary determination steps:	20
5.3 The battery cannot be charged or discharged	20
6. EMERGENCY SITUATIONS	21

1. Safety Precautions



Reminding

- 1) It is very important and necessary to read the user manual carefully (in the accessories) before installing or using battery. Failure to do so or to follow any of the instructions or warnings in this document can result in electrical shock, serious injury, or death, or can damage battery, potentially rendering it inoperable.
- 2) If the battery is stored for long time, it is required to charge it every six months, and the SOC should be no less than 90%;
- 3) Battery needs to be recharged within 12 hours, after fully discharged;
- 4) Do not expose cable outside;
- 5) All the battery terminals must be disconnected for maintenance;
- 6) Please contact the supplier within 24 hours if there is something abnormal.
- 7) Do not use cleaning solvents to clean battery;
- 8) Do not expose battery to flammable or harsh chemicals or vapors;
- 9) Do not paint any part of battery, include any internal or external components;
- 10) Do not connect battery with PV solar wiring directly;
- 11) Any foreign object is prohibited to insert into any part of battery.
- 12) The warranty claims are excluded for direct or indirect damage due to items above.



Li-ion 

Warning

1.1 Before Connecting

- 1) After unpacking, please check product and packing list first, if product is damaged or lack of parts, please contact with the local retailer;
- 2) Before installation, be sure to cut off the grid power and make sure the battery is in the turned-off mode;
- 3) Wiring must be correct, do not mistake the positive and negative cables, and ensure no short circuit with the external device;
- 4) It is prohibited to connect the battery and AC power directly;
- 5) The embedded BMS in the battery is designed for 24VDC, please DO NOT connect battery in series;
- 6) Battery system must be well grounding and the resistance must be less than 1Ω;



- 7) Please ensure the electrical parameters of the battery system are compatible with related equipment;
- 8) Keep the battery away from water and fire.

1.2 In Using

- 1) If the battery system needs to be moved or repaired, the power must be cut off and the battery is completely shut down;
- 2) It is prohibited to connect the battery with a different type of battery.
- 3) It is prohibited to put the batteries working with a faulty or incompatible inverter;
- 4) It is prohibited to disassemble the battery (QC tab removed or damaged);
- 5) In case of fire, only a dry powder fire extinguisher can be used, liquid fire extinguishers are prohibited;
- 6) Please do not open, repair or disassemble the battery except staffs from Pylontech or authorized by Pylontech. We do not undertake any consequences or related responsibility which because of violation of safety operation or violating of design, production and equipment safety standards.

2. Introduction

UP2500 lithium iron phosphate battery is one of new energy storage products developed and produced by Pylontech, it can be used to support reliable power for various types of equipment and systems. UP2500 is especially suitable for application scene of high power, limited installation space, restricted load-bearing and long cycle life.

UP2500 has built-in BMS battery management system, which can manage and monitor cells information including voltage, current and temperature. What's more, BMS can balance cells charging and discharging to extend cycle life.

Multiple batteries can connect in parallel to expand capacity and power in parallel for larger capacity and longer power supporting duration requirements.

2.1 features:

- The whole module is non-toxic, non-polluting and environmentally friendly;
- Cathode material is made from LiFePO₄ with safety performance and long cycle life;
- Battery management system (BMS) has protection functions including over-discharge, over-charge, over-current and high/low temperature;
- The system can automatically manage charge and discharge state and balance current and voltage of each cell;
- Flexible configuration, multiple battery modules can be in parallel for expanding capacity and power
- Adopted self-cooling mode rapidly reduced system entire noise;
The module has less self-discharge, up to 6 months without charging it on shelf, no memory effect, excellent performance of shallow charge and discharge;
- Working temperature range is from -10°C to 55°C, (Charging 0~55°C; discharging -10~55°C) with excellent discharge performance and cycle life;
- Small size and light weight, standard of 19-inch embedded designed module is comfortable for installation and maintenance;

2.2 Specifications

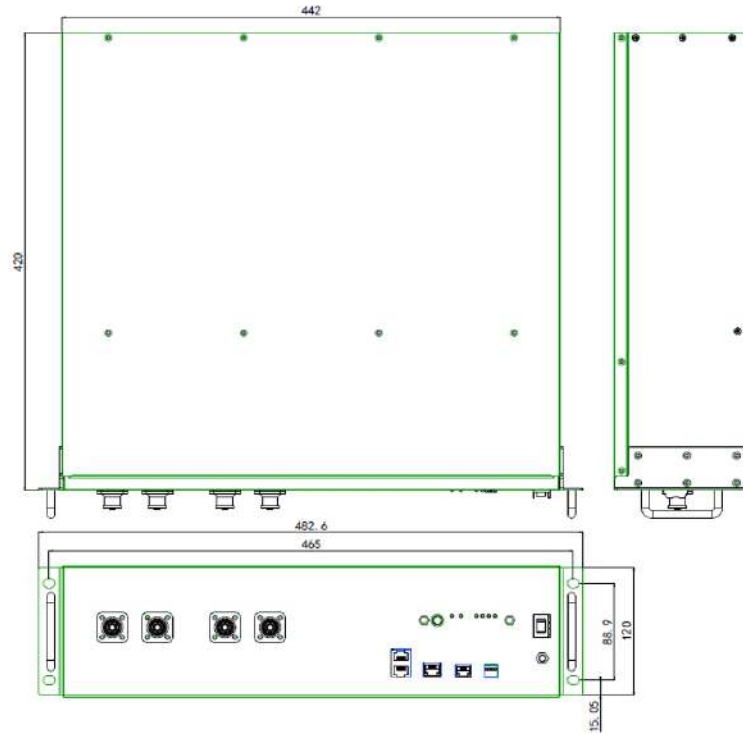

Basic Parameters	UP2500
Nominal Voltage (V)	25.6
Nominal Capacity (Wh)	2840
Usable Capacity (Wh)	2550
Dimension (mm)	442*420*120
Weight (Kg)	26.5
Discharge Voltage (V)	23.2 ~ 28.5
Charge Voltage (V)	28.2 ~ 28.5
Recommend Charge/Discharge Current (A)	55
Max. Charge/Discharge Current (A)	85
Peak Charge/Discharge Current (A)	100A@15sec
Communication	RS485 / CAN
Configuration (max. in 1 battery group)	20pcs
Working Temperature	0°C~55°C Charge
	-10°C~55°C Discharge
Shelf Temperature	-20°C~60°C
Ingress Protection	IP20
Humidity	5% ~ 95% (RH)
Altitude	<2000m
Certification	IEC62619 / CE/ RoHS / UN38.3
Design life	10+ Years (25°C/77°F)

2.3 Equipment Interface Instruction

This section details the front panel of the interface functions.

UP2500 Product Front Interface

Power / SW Switch

Power Switch: ON: the battery standby, no output. OFF: turn off the battery completely.

SW Switch: Press 2s to turn on or turn off battery

SOC

SOC light: 4 green LED to show the battery's current capacity.

Alarm

Alarm light: YELLOW LED to show the battery has alarm, Combine with SOC LEDs to show which kind of alarm in detail. Please check below table '**LED Indicators Instructions**' for the detailed definition.

Protection

Protection light: RED LED to show the battery is under BMS protection. Combine with SOC LEDs to show which kind of protection in detail. Please check below table '**LED Indicators Instructions**' for the detailed definition.

LED Status Indicators

LED Indicators Instructions

It's important to check the detailed alarm/protection definition follow the below table for trouble-shooting and maintenance service.

Condition	Protect	ALM	100~76%	75~51%	50~26%	25~0%	Description
Turn off	●	●	●	●	●	●	All LED lighting until battery is Off.
Power off	-	-	-	-	-	-	
Turn on	●	●	●	●	●	●	Flash once.
Idle				■			Current $\leq \pm 0.1A$; Only current SOC status LED slowly flash.
Charge				●			Only current SOC status LED constant lighting on.
Float charge				●●●●			SOC $\geq 99\%$, $0.1A \leq$ Current $\leq 0.5A$ Highest SOC status LED constant lighting on, rest SOC LEDs flash per sec.
Discharge			100-76% ●●●● → 75-51% ●●●● → 50-26% ●● → 25-0% ●				Residual SOC LEDs flash per sec.
Soft start	-	-	●	●	●	●	All SOC LEDs constant lighting on, pre-charge circuit is working.

Alarm	-	●					Alarm: Over Voltage, Low Voltage, Cell High/Low Temperature, MOS high temperature, high current.
	-	●					
	-	●					
	-		Low SOC (SOC≤10% or single cell voltage≤3V).				
Protection	●		●				Charge MOS OFF. Possible reason: charging over current 1/2; Over Voltage.
	●						Discharge MOS OFF. Possible reason: discharging over current 1/2; Low Voltage; Short circuit; Reverse connected.
	●		●				Charge and discharge MOS all OFF. Possible reason: Over/Low Temperature; MOS Over Temperature; i2c error.
			Show SOC				Internal communication error; Address assignment error.
	●	●					Critical failure: MOSFAIL; FUSE broken.
: flash 1.5s off/0.5s on			/ / : flash 1s off/1s on			/ / : constant lighting	

ADD Switch

ADD Switch: 4 ADD switches, **Dip1** to definite different baud rate ("0" is 115200, "1" is 9600). "0" and "1", refer to picture right. "0XXX" setup the baud rate 115200, and "1XXX" setup the baud rate 9600. **The settings will be active only after restart the battery.**



Using RS485: all batteries need to set the ADD switch. And should be the same.

Using CAN: the ADD switch has no influence on CAN baud rate.

Console

Console Communication Terminal: (RJ11 port) for professional engineer to debug or service.

L 0/1 / RS485

Link Port0/1 or RS485 Communication Terminal: (RJ45 port) follow Pylon Low voltage protocol RS485 for UP2500, for communication between multiple parallel batteries and between master battery to host equipment.

CAN

CAN Communication Terminal: (RJ45 port) follow Pylon Low voltage protocol CAN, for communication between master battery and host equipment.

Definition of RJ45 Port Pin

No.	RS485 Pin	CAN Pin
1	--	
2	--	GND
3	--	
4	--	CAN H
5	--	CAN L
6	GND	
7	RS485A	
8	RS485B	

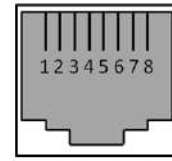

RJ45 Port



RJ45 Plug

Definition of RJ11 Port Pin

No.	RS232 Pin
1	GND
2	RXD
3	TXD
4	GND

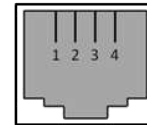

RJ11 Port

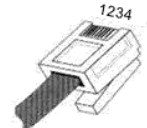

RJ11 Plug

Power Terminals +/-

Power cable terminals: there are two pair of terminals with same function, one connects to equipment, the other one paralleling to other battery module for capacity expanding. For each single module, each terminal can achieve charging and discharging function. For power cables it must keep pressing this Lock Button during pulling out the power plug.



BMS function:

Protection and Alarm	Management and Monitor
Charge/Discharge Cut-off	Cells Balance
Charge Over Voltage	Intelligent Charge Model
Discharge Under Voltage	Capacity Retention Calculate
Charge/Discharge Over Current	Administrator Monitor
High/Low Temperature	Operation Record
Short Circuit	Soft Start
	Hot Swap

3. Safe handling of lithium batteries Guide

3.1 Schematic Diagram of Solution

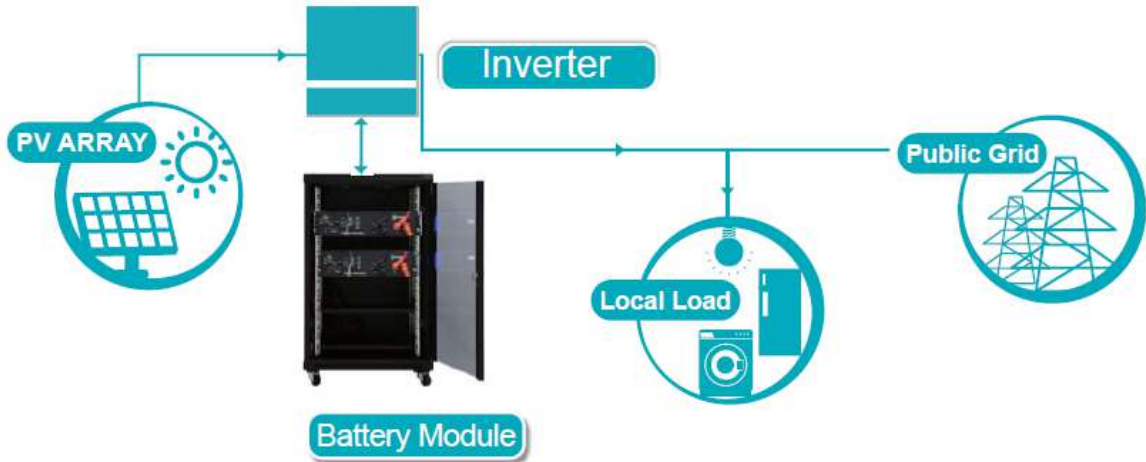

3.2 Explanation of Symbol

DANGER

DANGER LOW DC VOLTAGE INSIDE
DANGER ARC FLASH & SHOCK HAZARD



- * Do not disconnect or disassemble by non-professional personnel.
- * Do not drop, deform, impact, cut or spearing with a sharp object.
- * Do not place at a children or pet touchable area.
- * Do not place near open flame or flammable material.
- * Do not cover or wrap the product case.
- * Do not sit or put heavy things on battery.
- * Do not touch the leaking liquid.
- * Avoid of direct sunlight.
- * Avoid of moisture or liquid.
- * The product Ingress Protection (IP) class is IP20.
- * Make sure the grounding connection set correctly before operation.
- * Follow the product manual to make wiring connection.
- * If leaking, fire, wet or damaged, switch off the breaker on DC side and stay away from battery.
- * Contact your supplier within 24 hours if anything failure happens.

3.3 Tools

The following tools are required to install the battery pack



Wire cutter



Crimping Modular Plier



Screw Driver

NOTE

Use properly insulated tools to prevent accidental electric shock or short circuits.

If insulated tools are not available, cover the entire exposed metal surfaces of the available tools, except their tips, with electrical tape.

3.4 Safety Gear

It is recommended to wear the following safety gear when dealing with the battery pack



Insulated gloves



Safety goggles



Safety shoes

4. Installation

4.1 Package Items

Unpacking and check the Packing List

1) For battery module package:

Two power cables and one communication cable for each battery package:

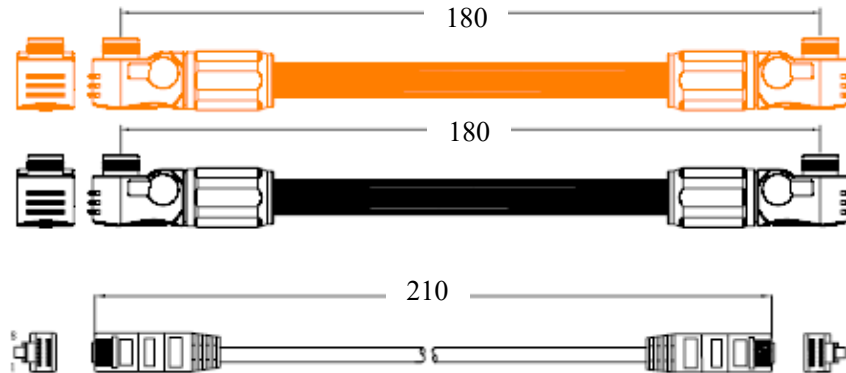

Grounding cable:

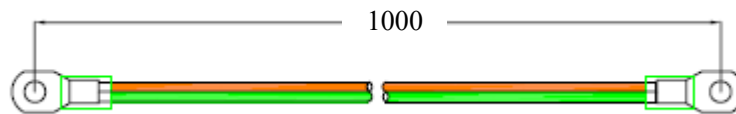

Grounding cables use 10AWG yellow-green cables.

UP2500 modules' grounding is based on metal directly touch between the module's surface (SGCC) and rack's surface. If uses normal rack, may need to remove the paint at the corresponding place.



Or install a grounding cable to the grounding point of the modules.



2) For battery system connects to inverter:

Two long power cables (current capacity **120A**) and one communication cable for each energy storage system:

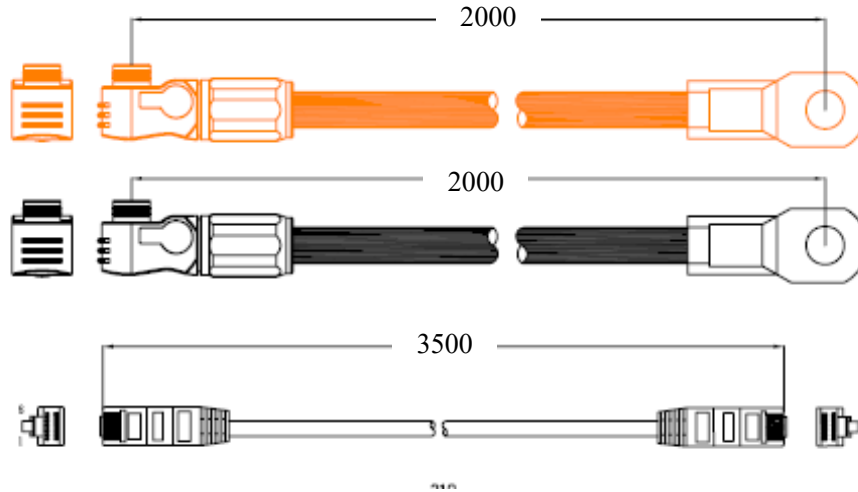

NOTE

These three long cables are **NOT in battery package**, they are in another **extra small cable box**. If there is anything missed, please contact dealer.

4.2 Installation Location

Make sure that the installation location meets the following conditions:

- ◆ The area is completely waterproof.
- ◆ The floor is flat and level.
- ◆ There are no flammable or explosive materials.
- ◆ The ambient temperature is within the range from 0°C to 50°C.
- ◆ The temperature and humidity are maintained at a constant level.
- ◆ There is minimal dust and dirt in the area.



CAUTION

If the ambient temperature is outside the operating range, the battery pack stops operating to protect itself. The optimal temperature range for the battery pack to operate is 0°C to 50°C. Frequent exposure to harsh temperatures may deteriorate the performance and life of the battery pack.

Installation

A. Put battery modules into cabinet and connect the cables:



RS485 communication:



CAN communication:

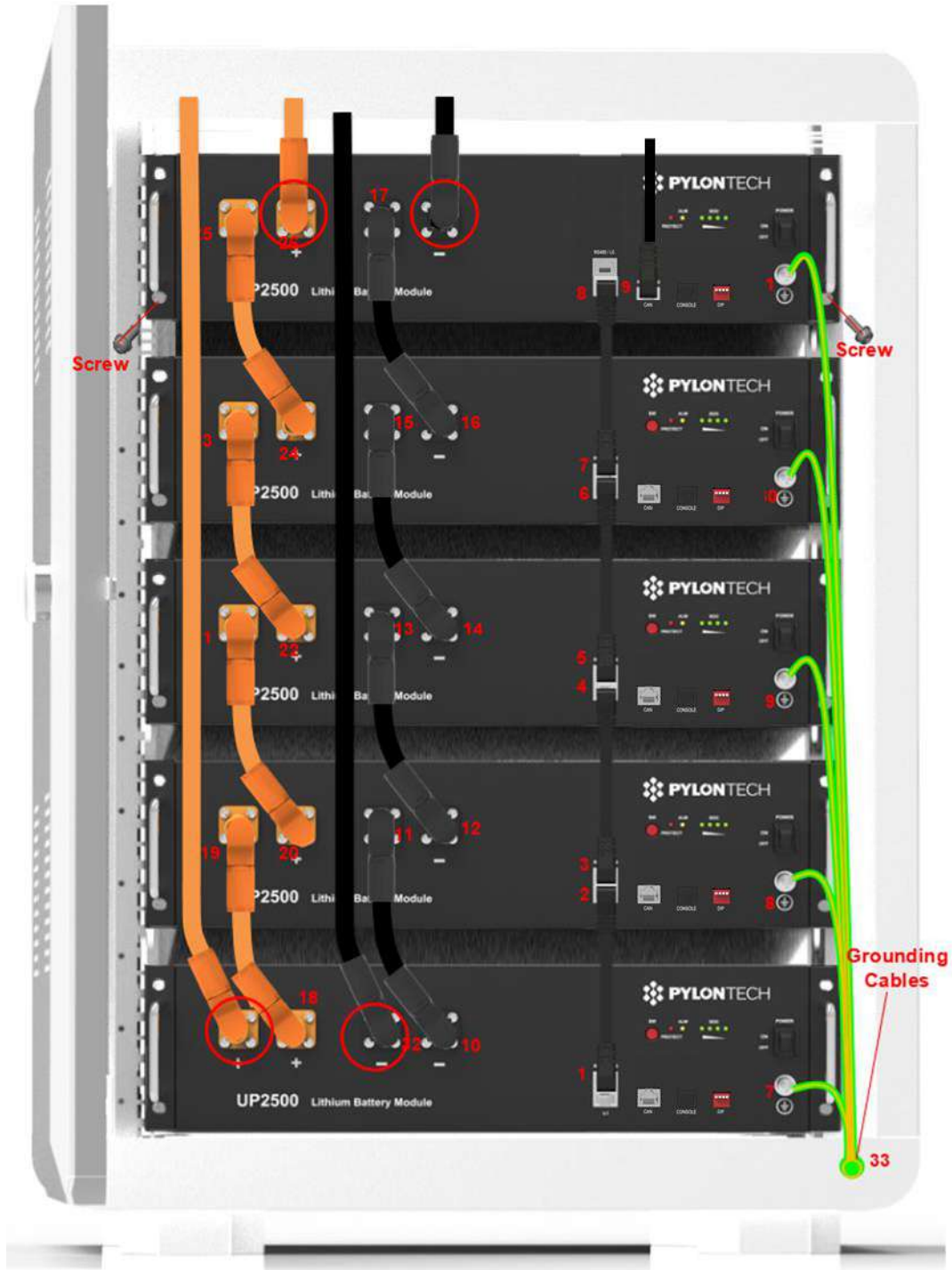

- (1) Put the battery into the cabinet;
- (2) Drive the 4 pcs screws;
- (3) Connect the cables between battery modules. If use



- (4) Connect the cables to inverter

The power cables' current capacity is **120A(peak)**. If the battery string's current over this limit, must configure 2 pairs of external power cables to reach **240A**.

If nominal current of battery system is higher than 100A, it is suggested to use 2 pairs of cables.

- (5) There shall be a manual disconnecting device (breaker, etc.) between battery system and inverter.

B. Power On

Double check all the power cable and communication cable, check the ADD switch.

- (1) Switch the breaker between battery system and inverter.

- (2) Switch power on

Switch on all the battery modules:



- (3) The one connects to inverter is the **Master Battery** Module, others are slaves (1 master battery configure with maximum 19 slave batteries).

- (4) Press the Start Button (**SW**) of **master battery** to power on, all the battery LED light will be on after master battery starts.

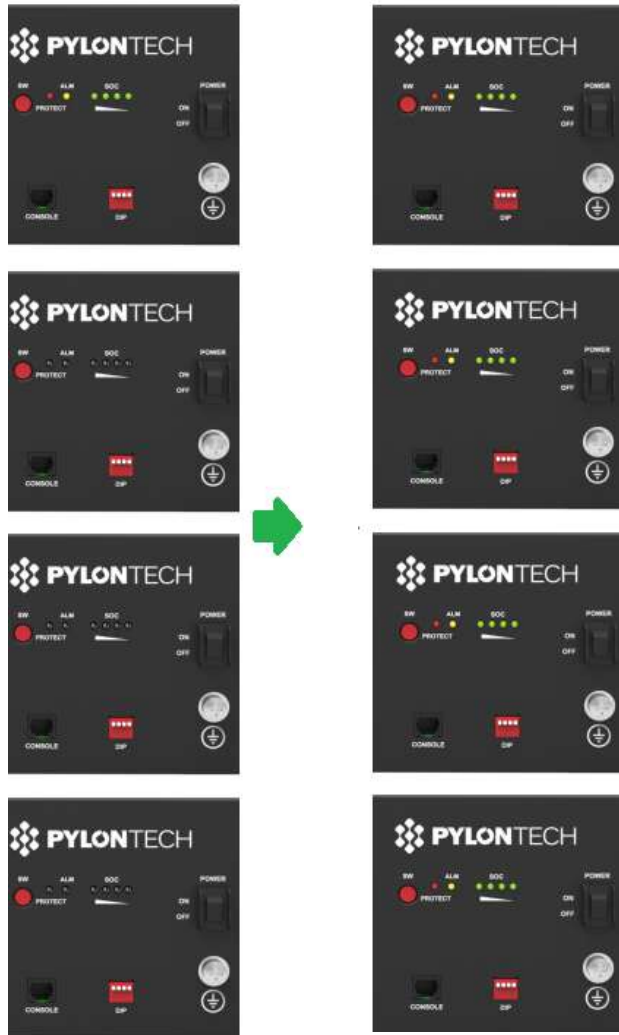

If all the battery LED lights on, and then off, which means the battery system is good and working.

5. Trouble Shooting Steps

Please always check the 'LED Indicators Instructions' table for the detailed faulty definition before any trouble-shooting steps.

5.1 Problem determination based on:

- 1) Whether the battery can be turned on or not;
- 2) If battery is turned on, check the red and yellow light is off, flashing or lighting;
- 3) If the red light is off, check whether the battery can be charged/discharged or not.

5.2 Preliminary determination steps:

1) Battery cannot turn on, switch on the lights are all no lighting or flashing.
If the battery external switch is ON, and the external power supply voltage is 26V or more, the battery still unable to turn on, please contact distributor.

2) The battery can be turned on, but red light is lighting, and cannot charge or discharge. If the red light is lighting, that means system is abnormal, please check values as following:

a) Temperature: Above 55°C or under -10°C, the battery could not work.

Solution: to move battery to the normal operating temperature range between -10°C and 55°C

b) Current: If current is >100A, battery protection will turn on.

Solution: Check whether current is too large or not, if it is, to change the settings on power supply side.

c) High Voltage: If charging voltage above 28.5V, battery protection will turn on.

Solution: Check whether voltage is too high or not, if it is, to change the settings on power supply side.

d) Low Voltage: When the battery discharges to 23.2V or less, battery protection will turn on.

Solution: Charge the battery for some time, the red light turns off

Excluding the four points above, if the faulty is still cannot be located, turn off power switch of the battery and repair.

5.3 The battery cannot be charged or discharged

1) Cannot be charged:

Disconnect the power cables, measure voltage on power side, if the voltage is 23.2~28.5V, restart the battery, connect the power cable and try again, if still not work, turn off battery and contact distributor.

2) Unable to discharge:

Disconnect the power cables and measure voltage on battery side, if it is <23.2V, please charge the battery; if voltage is above 25V and still cannot discharge, turn off battery and contact distributor.

6. Emergency Situations

1) Leaking Batteries

If the battery pack leaks electrolyte, avoid contact with the leaking liquid or gas. If one is exposed to the leaked substance, immediately perform the actions described below.

Inhalation: Evacuate the contaminated area, and seek medical attention.

Contact with eyes: Rinse eyes with flowing water for 15 minutes, and seek medical attention.

Contact with skin: Wash the affected area thoroughly with soap and water, and seek medical attention.

Ingestion: Induce vomiting, and seek medical attention.

2) Fire

NO WATER! Only dry powder fire extinguisher can be used; if possible, move the battery pack to a safe area before it catches fire.

3) Wet Batteries

If the battery pack is wet or submerged in water, do not let people access it, and then contact Pylontech or an authorized dealer for technical support.

4) Damaged Batteries

Damaged batteries are dangerous and must be handled with the utmost care. They are not fit for use and may pose a danger to people or property. If the battery pack seems to be damaged, pack it in its original container, and then return it to Pylontech or an authorized dealer.

NOTE

Damaged batteries may leak electrolyte or produce flammable gas. If such damage occurs, please contact Pylontech: service@pylontech.com.cn



Pylon Technologies Co., Ltd.

No. 73, Lane 887, Zu Chongzhi Road, Zhangjiang Hi-Tech Park Pudong,
Shanghai 201203, China



Pylon Technologies Co., Ltd.

No. 73, Lane 887, ZuChongzhi Road, Zhangjiang Hi-Tech Park

Pudong, Shanghai 201203, China

T +86-21-51317699 | F +86-21-51317698

E service@pylontech.com.cn

W www.pylontech.com.cn